

Wiring Diagrams - GFCIs

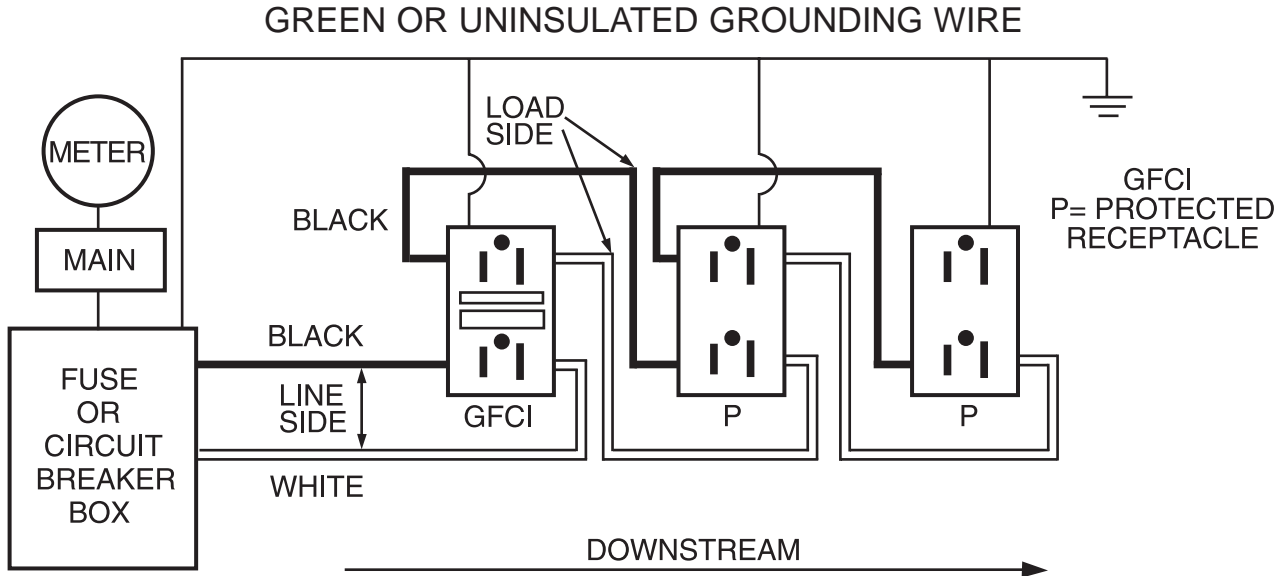

Wiring Diagram GFCI Receptacle, Feed-Thru Installation

To protect the entire branch circuit the GFCI must be the first receptacle from the fuse or circuit breaker box. Receptacles on the circuit between the GFCI and the box will not be protected, but receptacles downstream from the GFCI will have protection.

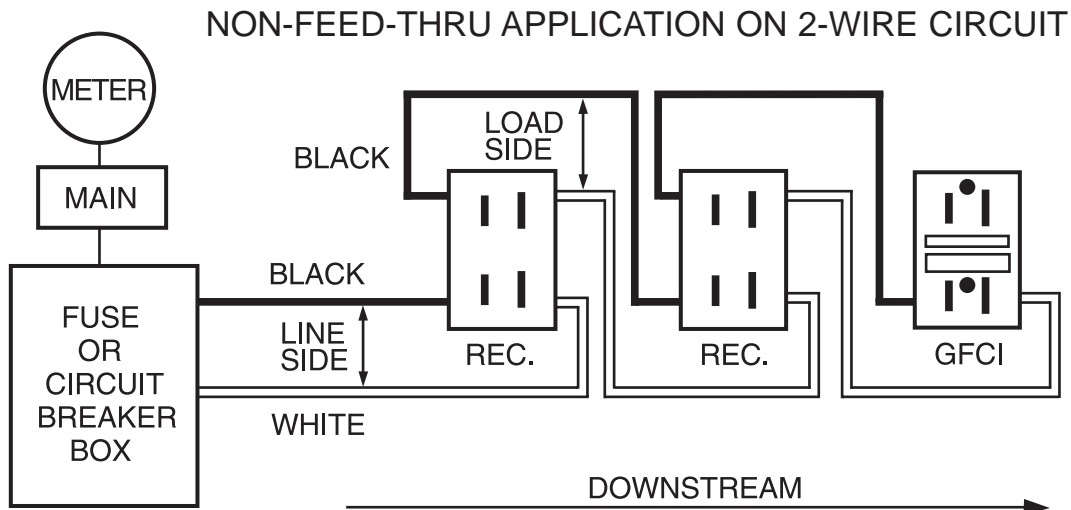

Wiring Diagram GFCI Receptacle, Non-Feed-Thru Installation

Terminal, or one-outlet-only protection can be achieved on a multi-wire circuit by connecting the hot and neutral line conductors to the corresponding line side terminals of the GFCI. Only the GFCI receptacle will be protected.

2 Pole 2 Wire Not Grounded

125V

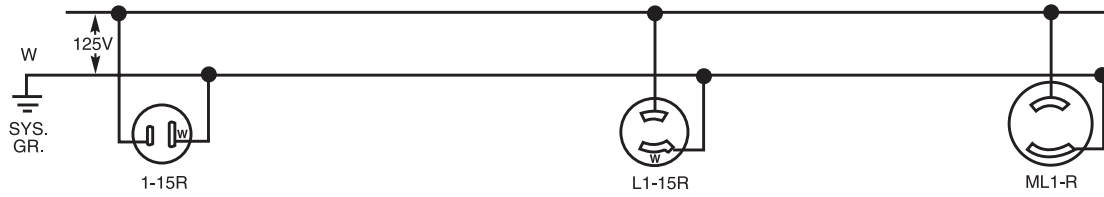

250V

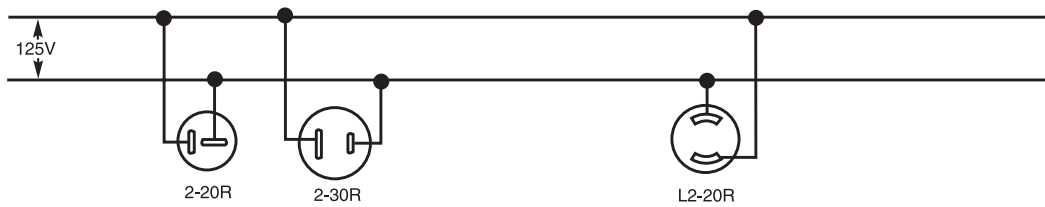

2 Pole 3 Wire Grounded

125V

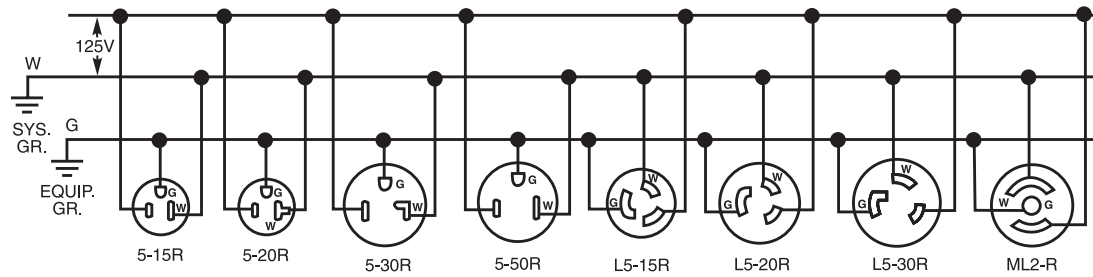

250V

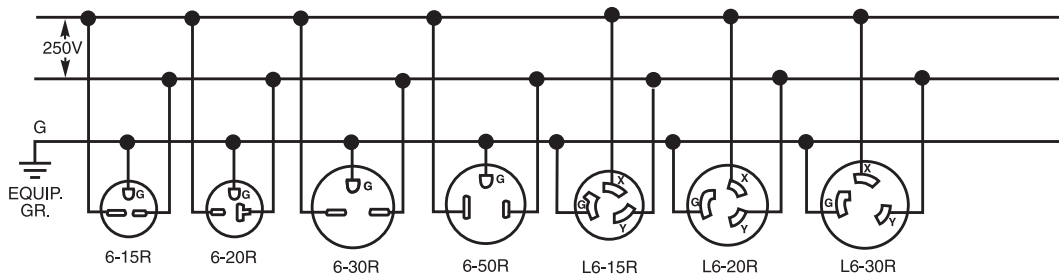

277VAC

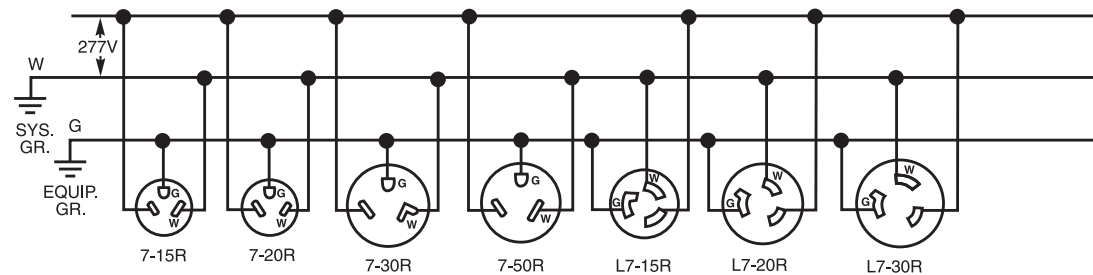

480VAC

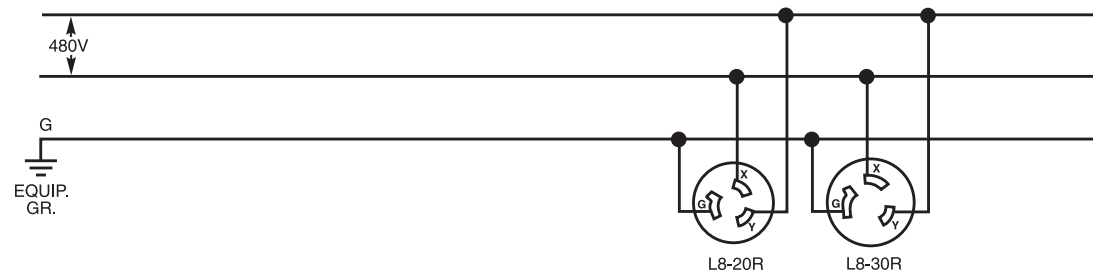

3 Pole 3 Wire Not Grounded

125V/250V

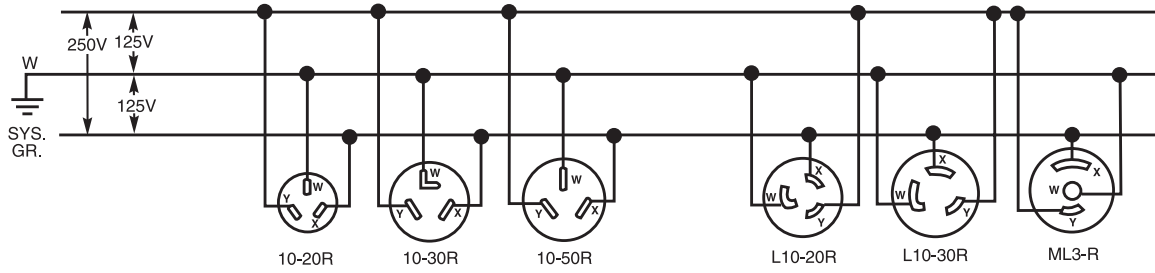

3ø250V

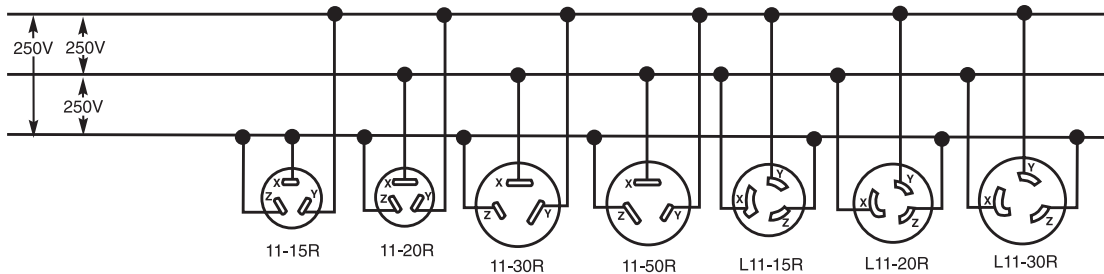

3 Pole 4 Wire Grounded

125V/250V

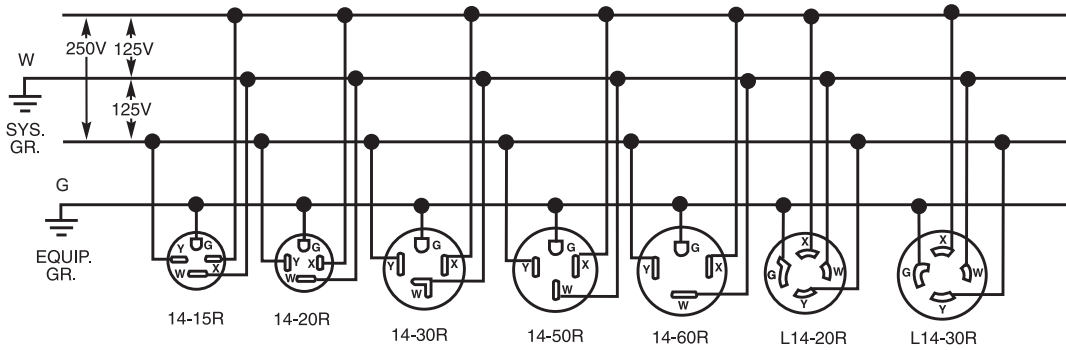

3ø250V

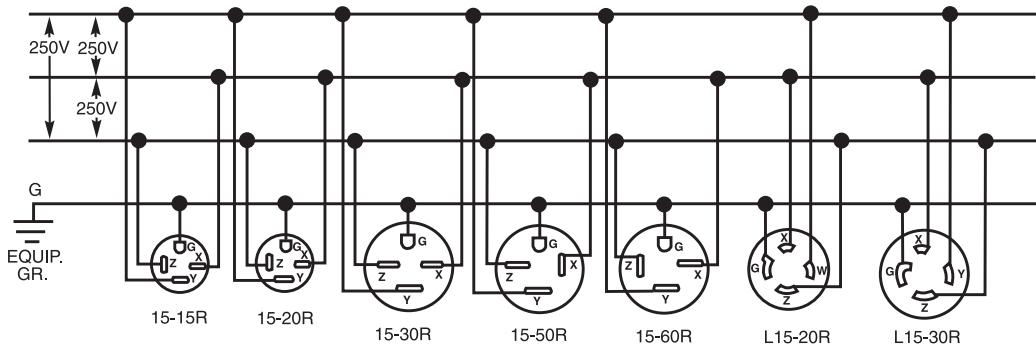

3ø480V

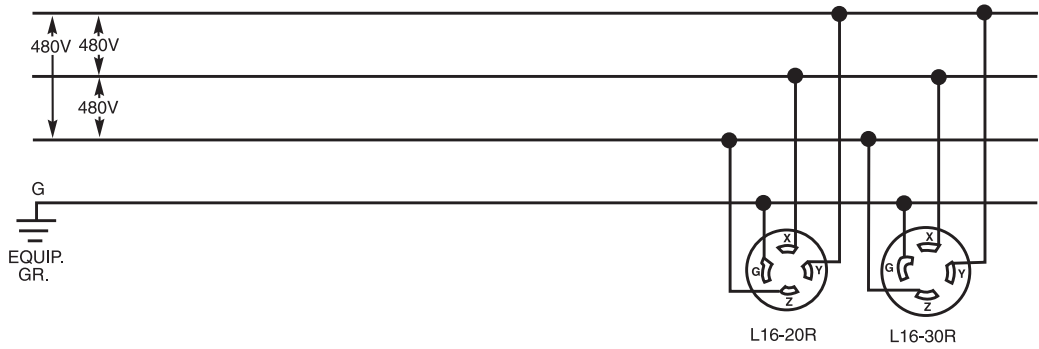

3ø600V

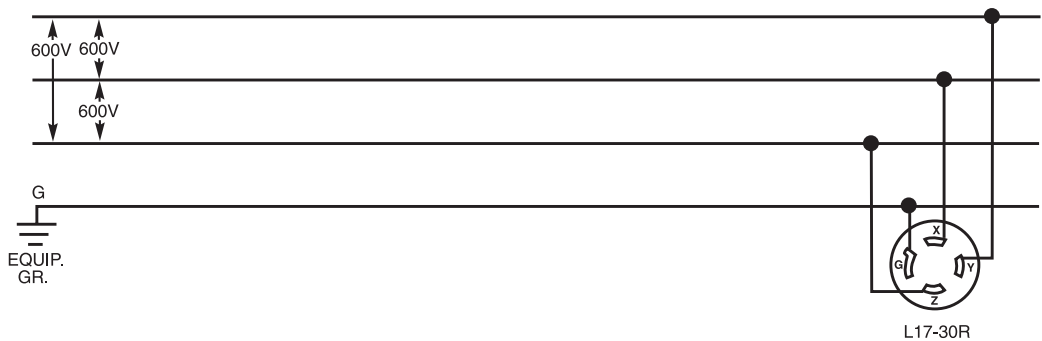

4 Pole 4 Wire Not Grounded

3 ϕ Y120V/208V

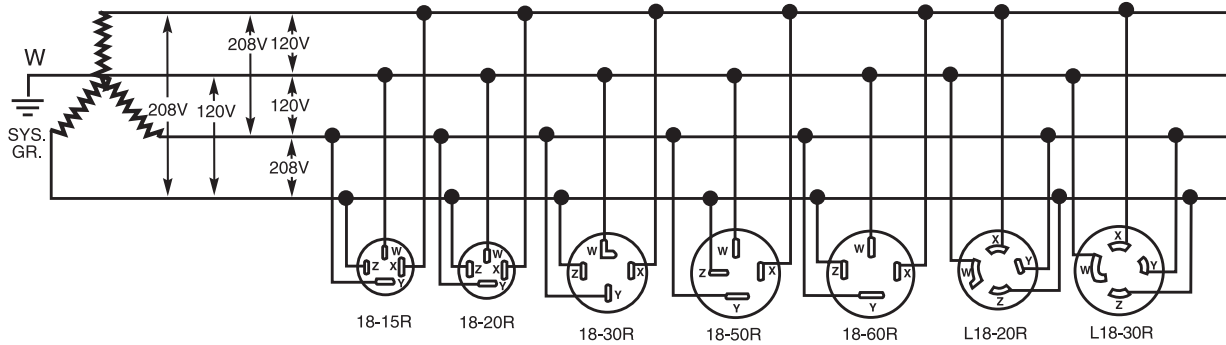

3 ϕ Y277/480V

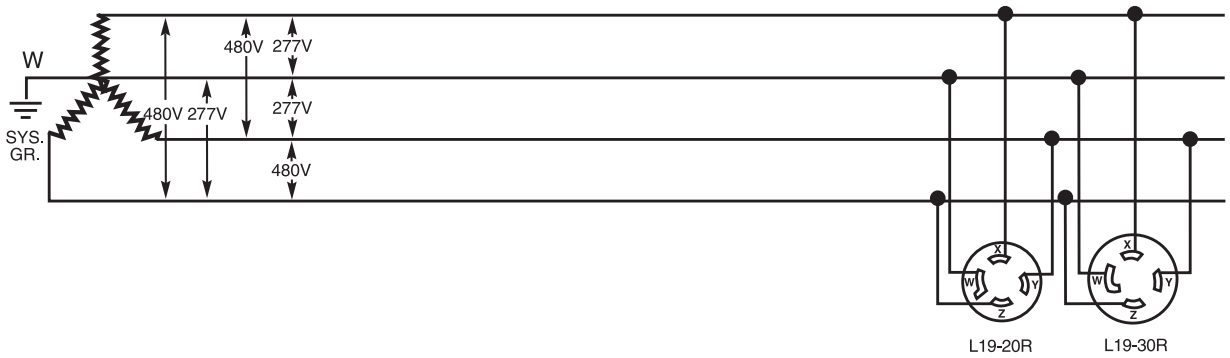

3 ϕ 347/600V

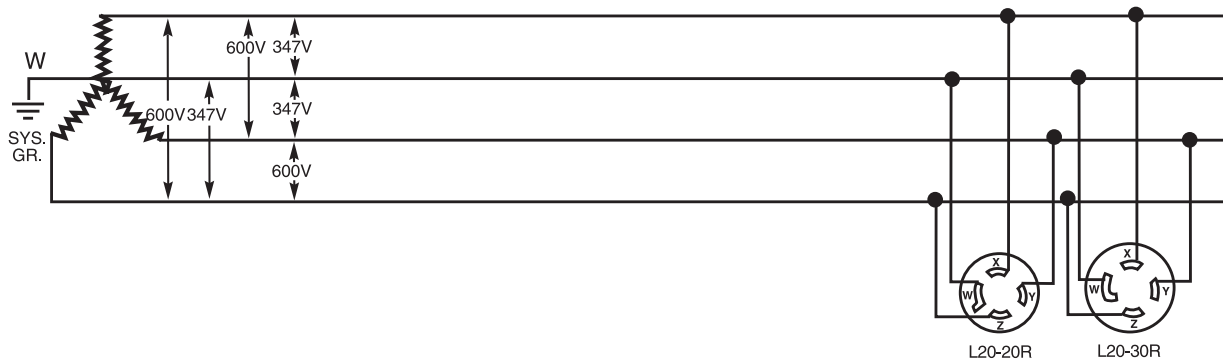

4 Pole 5 Wire Grounded

3 ϕ Y120V/208V

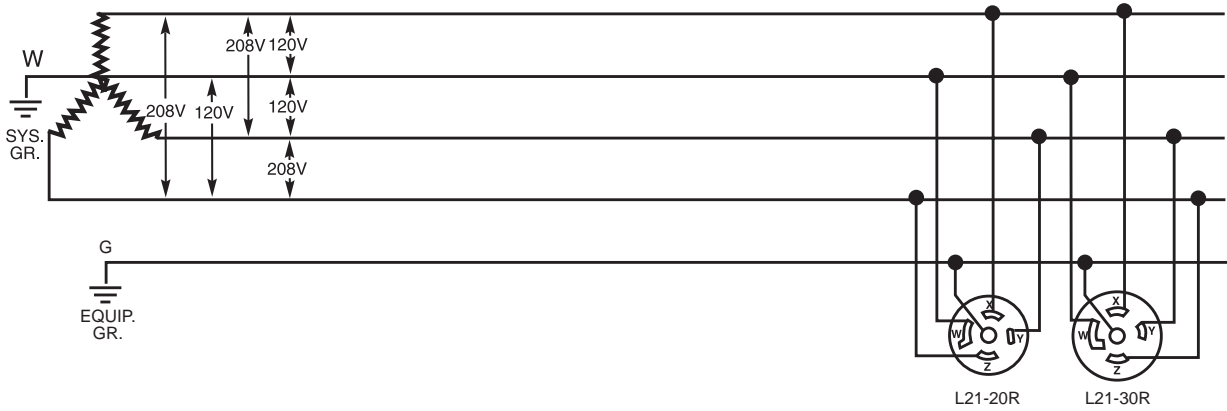

3 ϕ Y277/480V

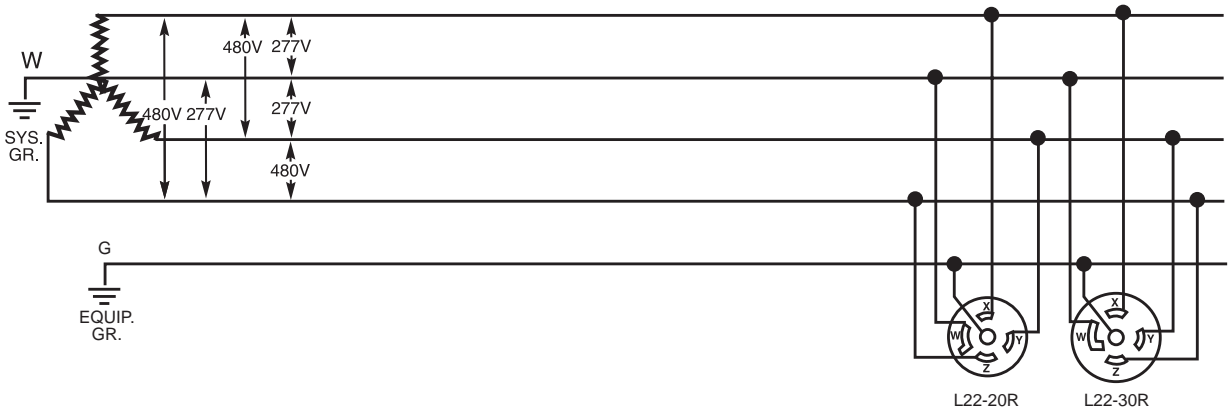

3 ϕ Y347/600V

