

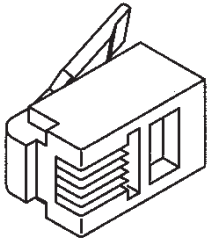
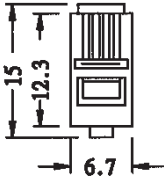
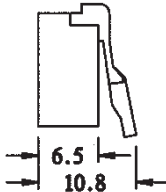
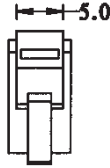
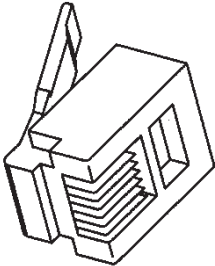
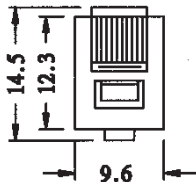
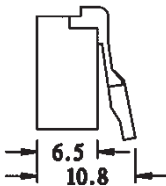
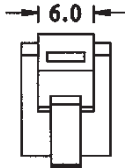
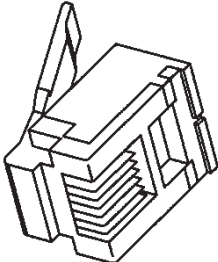
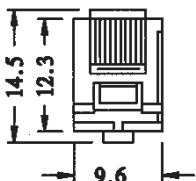
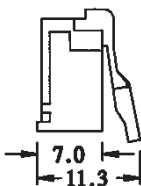
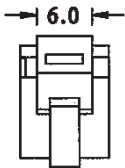
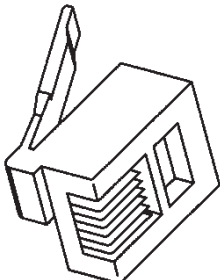
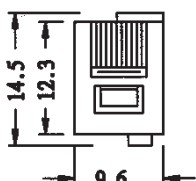
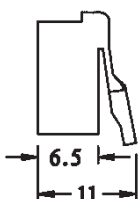
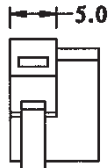
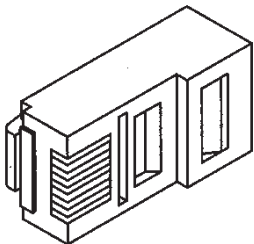
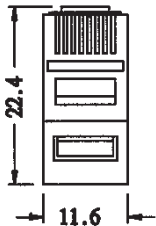
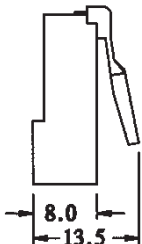
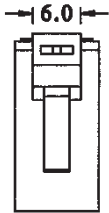
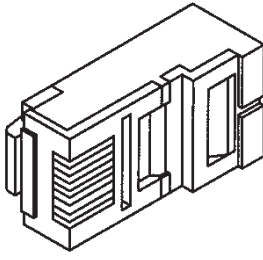
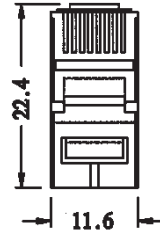
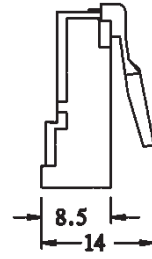
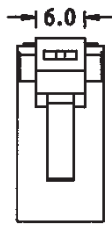
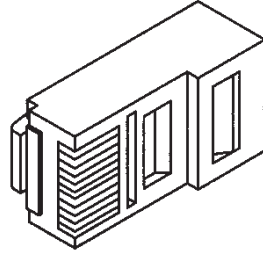
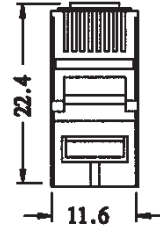
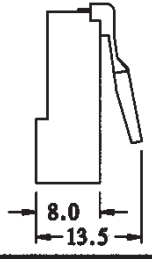
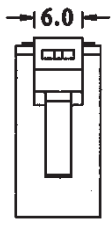
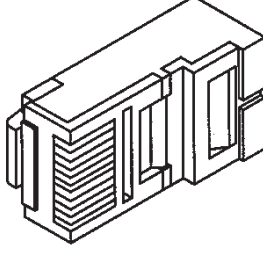
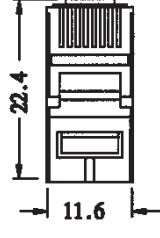
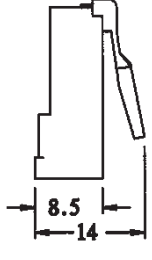
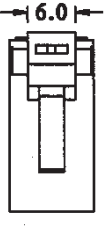
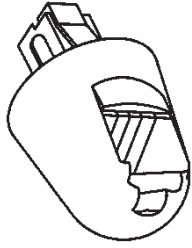
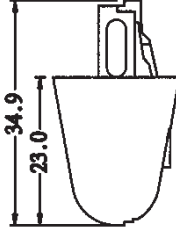
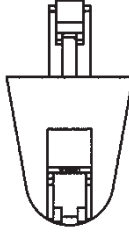
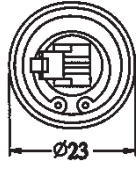
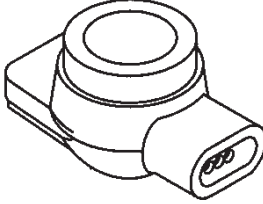

MH		MODULAR PLUG		
				4P4C
MP		MODULAR PLUG		
				MP-2 (6P2C) MP-4 (6P4C) MP-6 (6P6C)
MP-S		MODULAR PLUG (SHIELDED)		
				MP-S2 (6P2C) MP-S4 (6P4C) MP-S6 (6P6C)
MP-D		MODULAR PLUG (DEC TYPE)		
				MP-D2 (6P2C) MP-D4 (6P4C) MP-D6 (6P6C)
MD8		MODULAR PLUG (8P-UNSHIELDED)		
				MD8-4 (8P4C) MD8-8 (8P8C)

MD8-S		MODULAR PLUG (8P-SHIELDED)		MD8-S4 (8P4C) MD8-S8 (8P8C)
				
MD10		MODULAR PLUG (10P-UNSHIELDED)		10P10C
				
MD10-S		MODULAR PLUG (10P-SHIELDED)		10P10C
				
HR-4PJ		ROTATEABLE JACK WITH PLUG		Use on handset only. HR-4PJ-L(long)
				
UR-101		UR CONNECTOR		Use for either two or three wires combination of 19 through 26 AWG
				

<p>UY-101 UY CONNECTOR</p>		<p>Use for two wires combination of 22 through 26 AWG.</p>
<p>UB-101 UB CONNECTOR</p>		<p>The space saves TAP connector. Use for 22 through 26 AWG.</p>
<p>MJ6T4 6P TO 4P ADAPTER</p>		<p>Convert 6P to 4P in modular jack.</p>
<p>MJ8T6 8P TO 6P ADAPTER</p>		<p>Convert 8P to 6P in modular jack.</p>
<p>USLT LINE-IN TESTER</p>		<p>Modular phone line tester.</p>

USILJ2

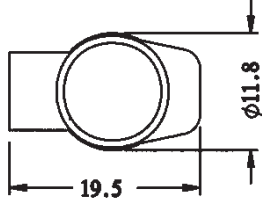
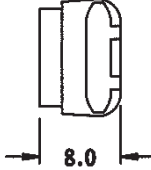
MODULAR JACK IN LINE COUPLER

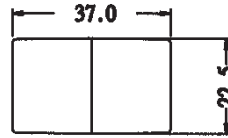
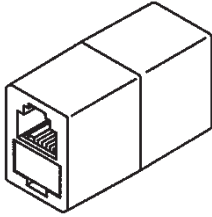

USILJ2-2 (6P2C)
USILJ2-4 (6P4C)
USILJ2-6 (6P6C)
USILJ2-8 (8P8C)
USILJ2-10 (10P10C)

USPJ

MODULAR SINGLE ADAPTER

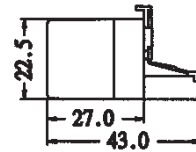
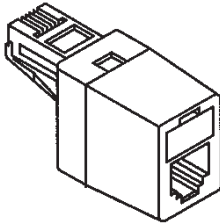

USPJ-2 (6P2C)
USPJ-4 (6P4C)
USPJ-6 (6P6C)

USPJ2

MODULAR DUPLEX ADAPTER

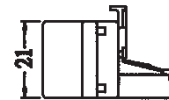
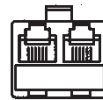
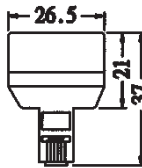
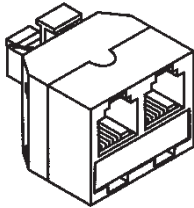

USPJ2-22 (6P2C)
USPJ2-44 (6P4C)
USPJ2-66 (6P6C)
USPJ2-2L (L1+L2)

USPJ2-48

MODULAR DUPLEX ADAPTER

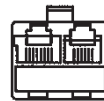
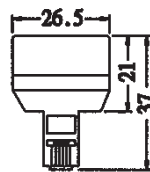
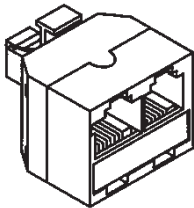







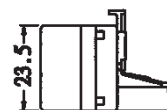
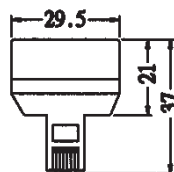
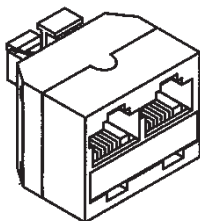



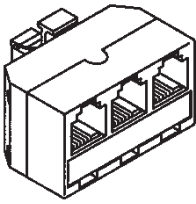
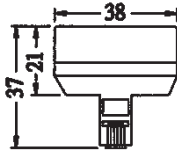

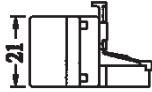
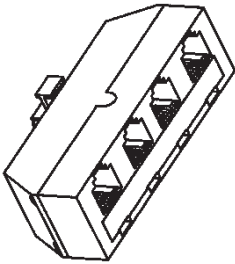
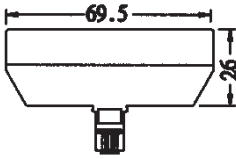
6P4C/8P6C with 2 shorting bars.

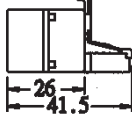
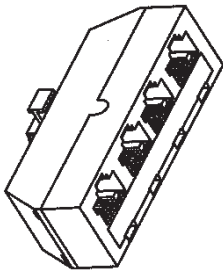
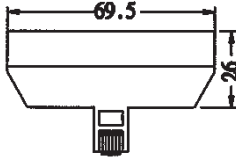
USPJ2-8

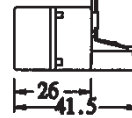
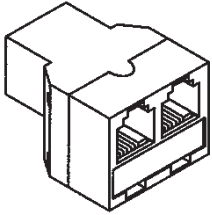
MODULAR DUPLEX ADAPTER(8P)

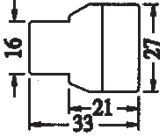

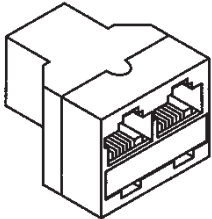

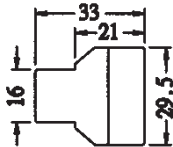
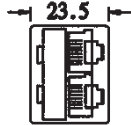

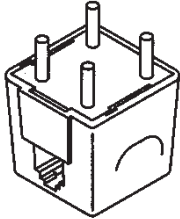
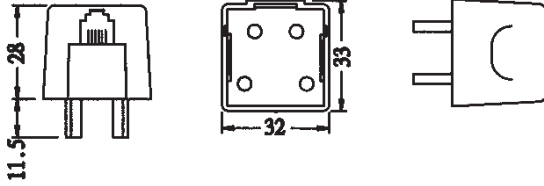
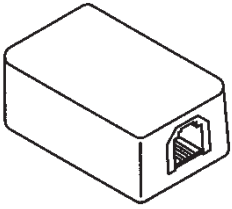
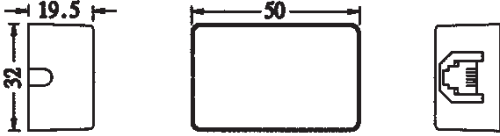
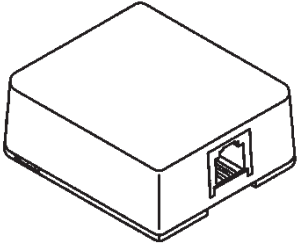
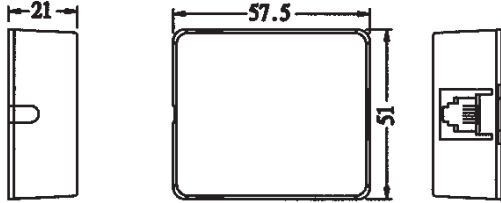
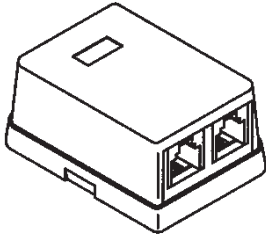
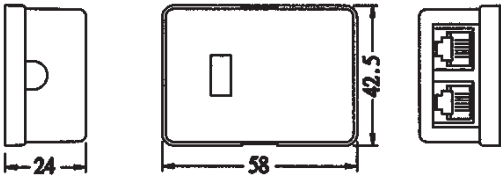
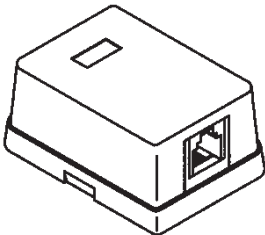
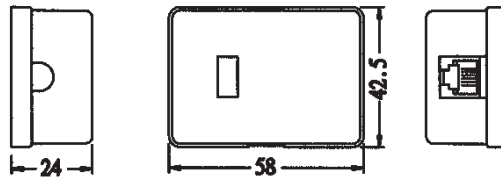

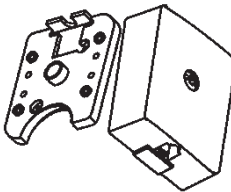
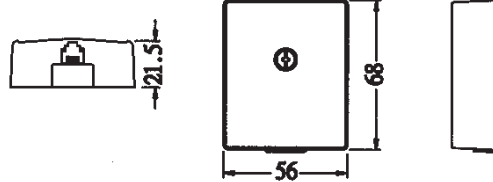
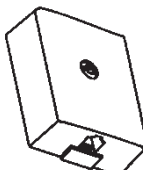
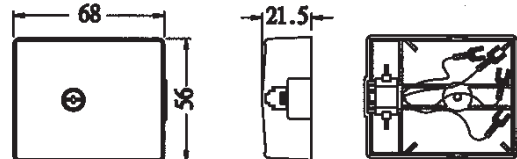
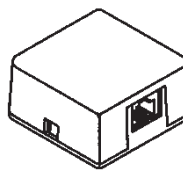
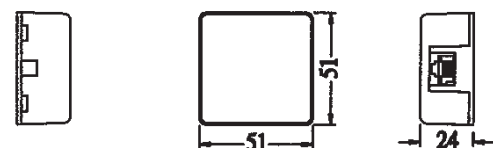
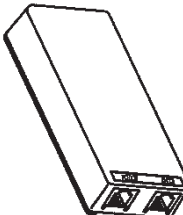
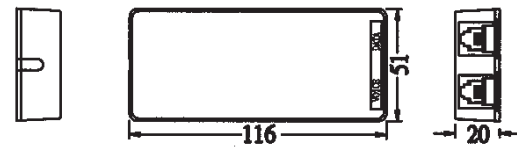
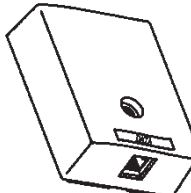
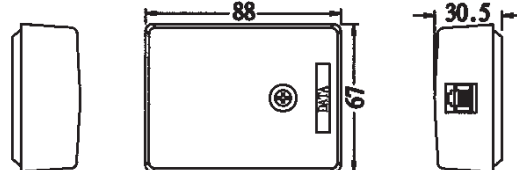

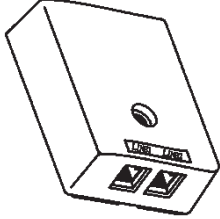

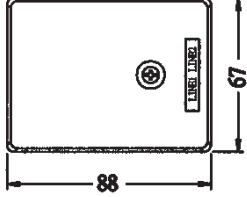
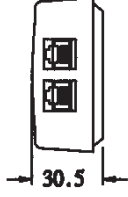
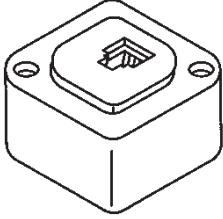
USPJ2-88
USPJ2-88D (KEYED)

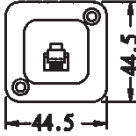
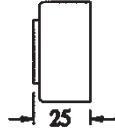
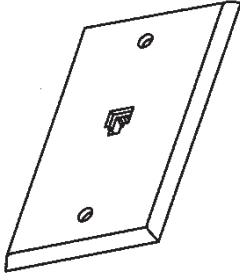
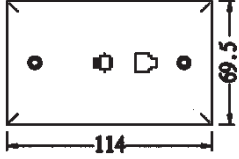
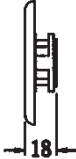
USPJ3		TRIPLEX ADAPTER	
			
<p>USPJ3-A (444) USPJ3-B (422) USPJ3-C (L1,L2,L1+L2) USPJ3-D (L1.L2.L3)</p>			
USPJ4-4		4-SOCKET ADAPTER(4P)	
			
<p>Four 6P4C JACKS.</p>			
USPJ4-8		4-SOCKET ADAPTER(8P)	
			
<p>Four 8P8C JACKS.</p>			
USJ-J2		MODULAR TRIPLEX ADAPTER	
			
<p>USJ-J2-2 (6P2C) USJ-J2-4 (6P4C) USJ-J2-6 (6P6C)</p>			
USJ-J2-8		MODULAR TRIPLEX ADAPTER(8P)	
			
<p>8P8C</p>			

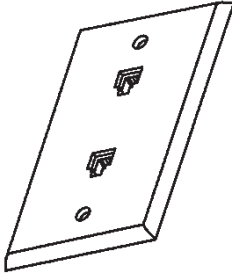
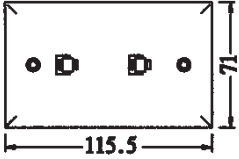
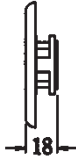
USJ-4P 4-PRONG ADAPTER WITH JACK		Convert standard 4 prong plug to modular jack
		
USSJ-A SUPER MINI SURFACE JACK		USSJ-A2 (6P2C) USSJ-A4 (6P4C) USSJ-A6 (6P6C)
		
USSJ-B SURFACE JACK		USSJ-B4 (6P4C) USSJ-B6 (6P6C) USSJ-B8 (8P8C)
		
USSJ-C MINI SURFACE JACK WITH DUAL SOCKETS		USSJ-C22 (6P2C) USSJ-C44 (6P4C)
		
USSJ-D MINI SURFACE JACK		USSJ-D2 (6P2C) USSJ-D4 (6P4C) USSJ-D6 (6P6C)
		

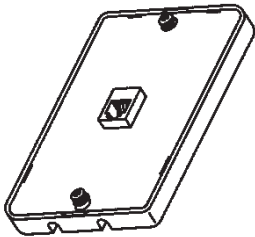
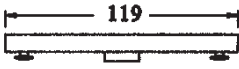
USSJ-E		SURFACE JACK WITH CONNECTION BASE	
		USSJ-E2 (6P2C) USSJ-E4 (6P4C) USSJ-E6 (6P6C)	
USSJ-F		SURFACE JACK COVER ASSEMBLY	
		USSJ-F2 (6P2C) USSJ-F4 (6P4C) USSJ-F6 (6P6C)	
USSJ-G		RJ31X SURFACE JACK	
		USSJ-G4 USSJ-G4S (Shorting Bar) USSJ-G8 USSJ-G8S (Shorting Bar)	
USSJ-H		SURFACE JACK WITH DUAL SOCKETS	
		USSJ-H44 (6P4C) USSJ-H66 (6P6C) USSJ-H88 (8P8C)	
USSJ-I		IDC TYPE SURFACE JACK	
		USSJ-I4 (6P4C) USSJ-I6 (6P6C) USSJ-I8 (8P8C)	

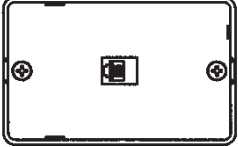
<p>USSJ-J IDC TYPE SURFACE JACK WITH DUAL SOCKETS</p>		<p>USSJ-J44 (6P4C) USSJ-J66 (6P6C) USSJ-J88 (8P8C)</p>
	  	
<p>USSJ-K MODULAR SURFACE JACK</p>		<p>USSJ-K4 (6P4C) USSJ-K6 (6P6C)</p>
	  	
<p>USFJ-A SINGLE WALL JACK</p>		<p>USFJ-A4 (6P4C) USFJ-A6 (6P6C) USFJ-A8 (8P8C)</p>
	  	
<p>USFJ-B DUPLEX WALL JACK</p>		<p>USFJ-B4 (6P4C) USFJ-B6 (6P6C) USFJ-B8 (8P8C)</p>
	  	
<p>USFJ-C CONVEX MODULAR JACK</p>		<p>USFJ-C4 (6P4C) USFJ-C6 (6P6C) USFJ-C8 (8P8C)</p>
	  	

USFJ-D

WALL PHONE JACK WITH TWO SIDE JACKS

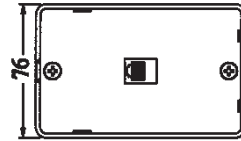
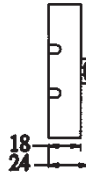
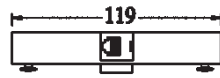
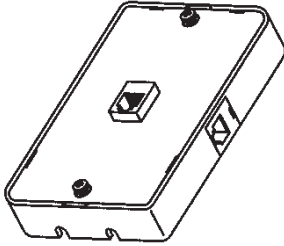

USFJ-D4
(6P4C)
USFJ-D6
(6P6C)

USFJ-E

MODULAR JACK WITH STAINLESS STEEL COVER

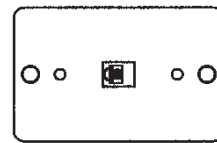
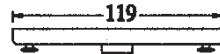
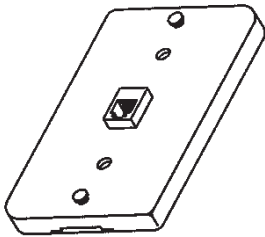

USFJ-E4
(6P4C)
USFJ-E6
(6P6C)

USFJ-F

FACE PLATE WITH PHONE SOCKET & F CONNECTOR

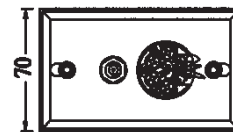
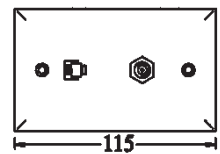
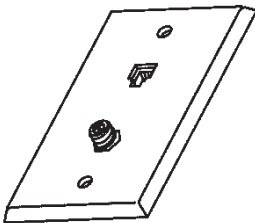

USFJ-F2
(6P2C)
USFJ-F4
(6P4C)
USFJ-F6
(6P6C)

USFJ-G

DECOROUS WALL PLATE (SEPARATION TYPE)

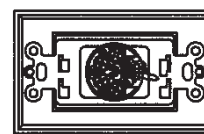
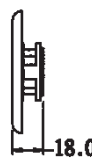
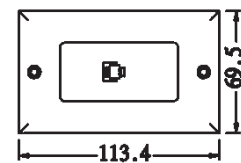
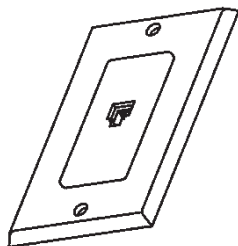

USFJ-G4
(6P4C)
USFJ-G6
(6P6C)

USFJ-G1

DECOROUS WALL PLATE INSERT



USFJ-G14
(6P4C)
USFJ-G16
(6P6C)

USFJ-H		OVAL WALL JACK		USFJ-H4 (6P4C) USFJ-H6 (6P6C)
USFJ-I		CIRCULAR WALL JACK		USFJ-I4 (6P4C) USFJ-I6 (6P6C)
USFJ-J		SQUARE WALL JACK		USFJ-J4 (6P4C) USFJ-J6 (6P6C)
USFJ-K		SQUARE WALL JACK WITH DUAL SOCKETS		USFJ-K4 (6P4C) USFJ-K6 (6P6C)
USFJ-L		DECOROUS WALL PLATE		USFJ-L4 (6P4C) USFJ-L6 (6P6C)

USFJ-M

DECOROUS WALL PLATE WITH DUAL SOCKETS

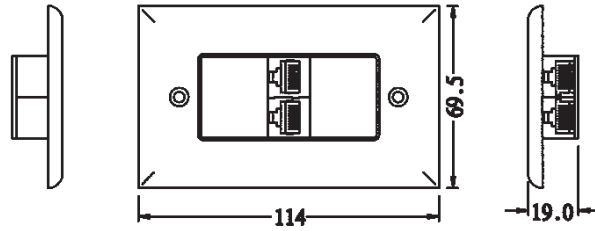
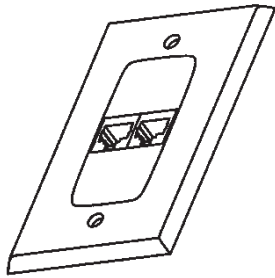

USFJ-M4
(6P4C)
USFJ-M6
(6P6C)

USBB

BOTTOM BOX

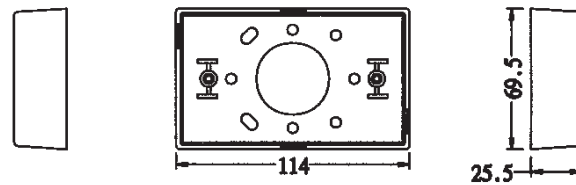
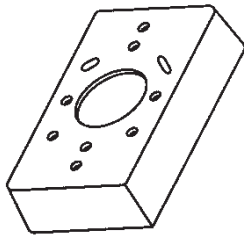

Bottom box
for wall jack.

USOJ

OUTSIDE WALL JACK

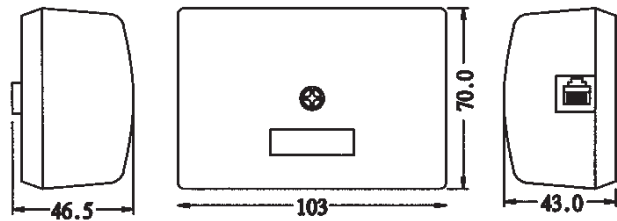
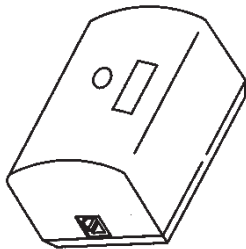

8P8C

USJ5-MP

5-LINE ADAPTER WITH US PLUG

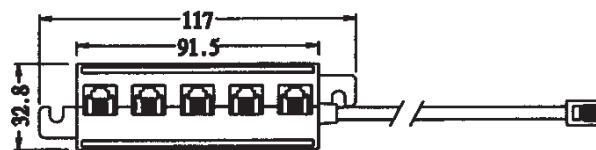
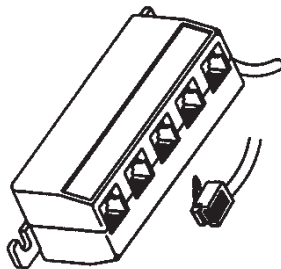



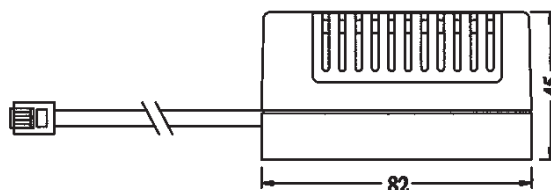
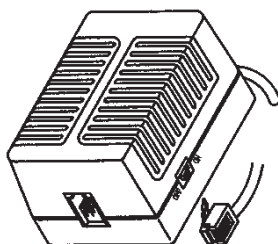

USJ5-401-MP
(1 FT)
USJ5-403-MP
(3 FT)

USBR-M

MECHANICAL BELL RINGER

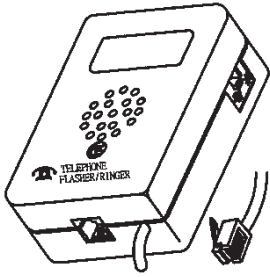
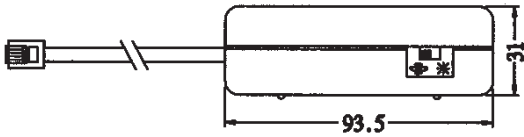
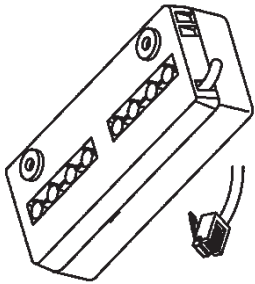
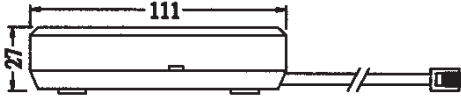
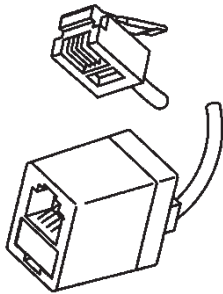
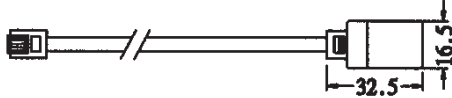
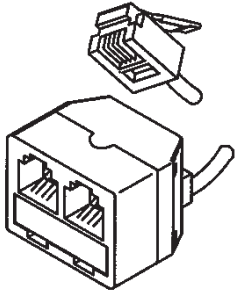

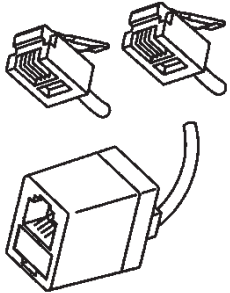
Provide louder
bell ring.

USBR-E ELECTRICAL BELL RINGER		
		Bell ring with light.
USJB SCREW TERMINAL JUNCTION BOX		
		Convert a modular outlet jack up to 4 additional extensions.
USP-407-MJ US PLUG TO US JACK WITH 7FT 4C CORD		
		USP-403-MJ (4C 3FT) USP-414-MJ (4C 14FT) USP-425-MJ (4C 25FT)
USP-407-MJ2 US PLUG TO DUAL US JACK WITH 7FT 4C CORD		
		USP-403-MJ2 (4C 3FT) USP-414-MJ2 (4C 14FT) USP-425-MJ2 (4C 25FT)
USJ-207-MP2 US JACK TO DUAL US PLUG WITH 7FT 2C CORD		
		MP2 are L1, L2 USJ-214-MP2 (2C 14FT) USJ-225-MP2 (2C 25FT)

USP-407-MP MP ON BOTH ENDS WITH 7FT 4C CORD

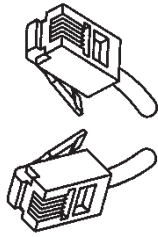

USP-403-MP (4C 3FT)
USP-414-MP (4C 14FT)
USP-425-MP (4C 25FT)

USP-407-Y US PLUG TO SPADE TERMINALS WITH 7FT 4C CORD

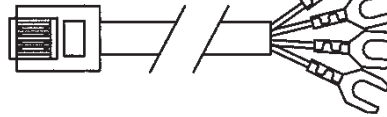
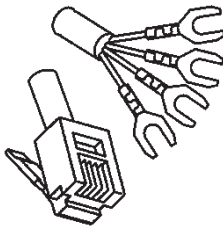

USP-403-Y (4C 3FT)
USP-414-Y (4C 14FT)
USP-425-Y (4C 25FT)

USH-T407-MH MH ON BOTH ENDS WITH 7FT 4C COILED CORD

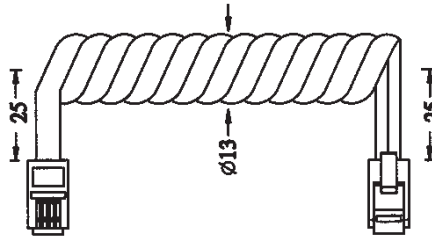
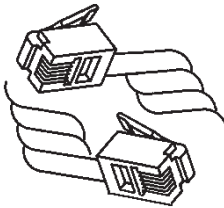

USH-T403-MH (4C 3FT)
USH-T414-MH (4C 14FT)
USH-T425-MH (4C 25FT)

USH-T407-Y US PLUG TO SPADE TERMINALS WITH 7FT 4C COILED CORD

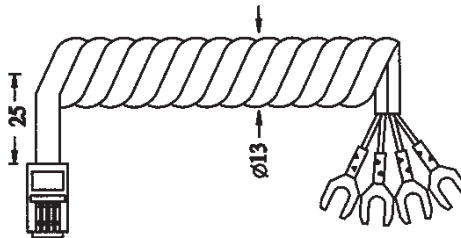
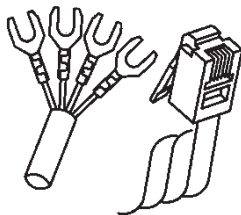

USH-T403-Y (4C 3FT)
USH-T414-Y (4C 14FT)
USH-T425-Y (4C 25FT)

USY-T407-Y SPADE TERMINALS ON BOTH ENDS WITH 7FT 4C COILED CORD

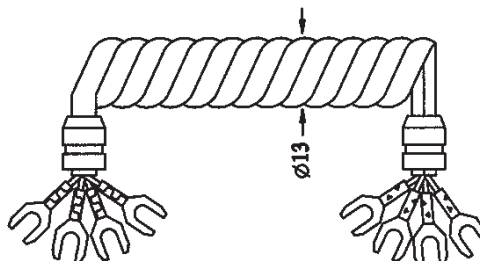
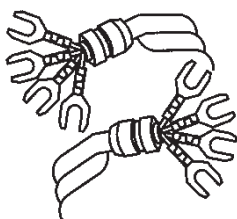

USY-T403-Y (4C 3FT)
USY-T414-Y (4C 14FT)
USPY-T425-Y (4C 25FT)

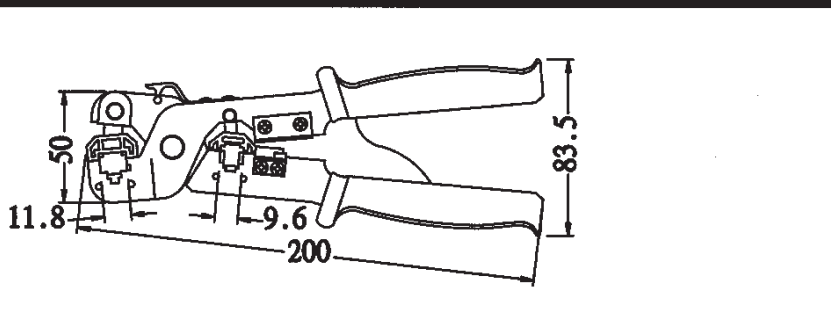
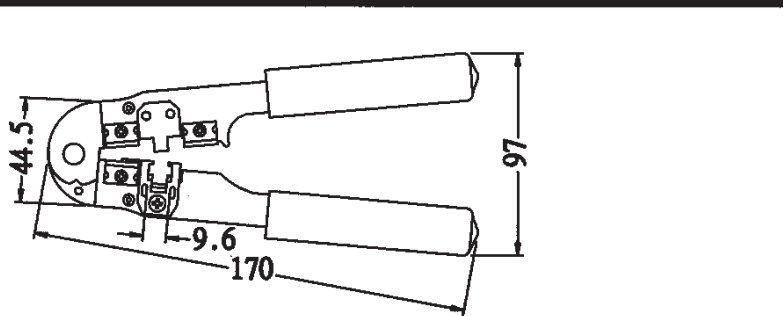
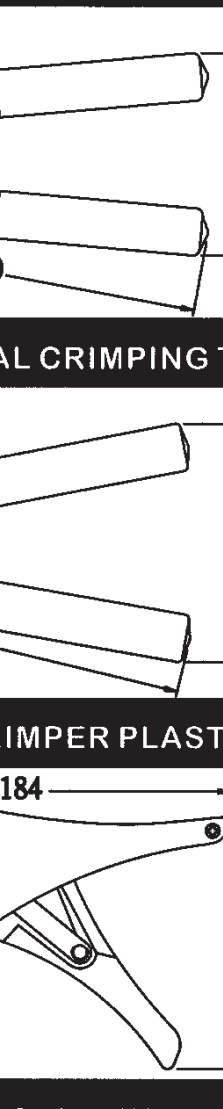
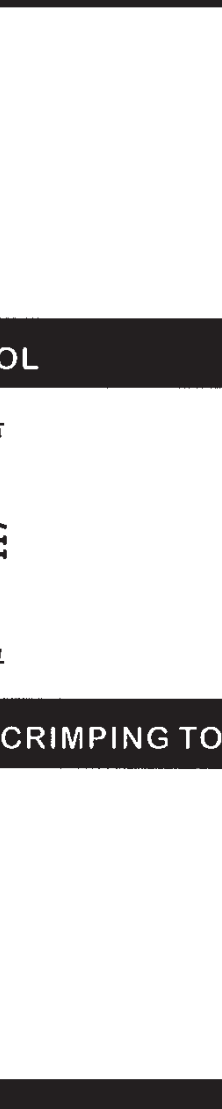
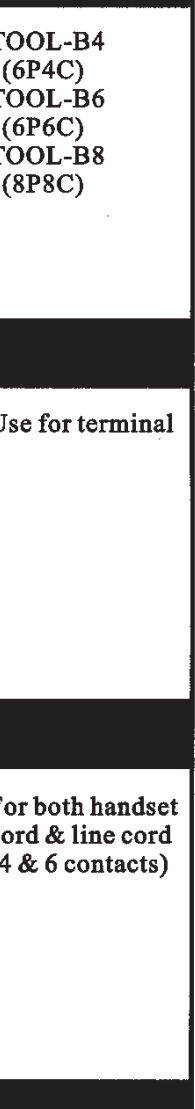
TOOL-A	DUAL CRIMPER METAL CRIMPING TOOL	
		<p>TOOL-A4/6 (4C/6C) TOOL-A4/8 (4C/8C) TOOL-A6/8 (6C/8C)</p>
TOOL-B	METAL CRIMPING TOOL	
		<p>TOOL-B4 (6P4C) TOOL-B6 (6P6C) TOOL-B8 (8P8C)</p>
TOOL-C	TERMINAL CRIMPING TOOL	
		<p>Use for terminal</p>
TOOL-D	DUAL CRIMPER PLASTIC CRIMPING TOOL	
		<p>For both handset cord & line cord (4 & 6 contacts)</p>
TOOL-E	PLASTIC CRIMPING TOOL	
		<p>TOOL-E4 (6P6C & 4P4C) TOOL-E6 (6P6C) TOOL-E8 (8P8C)</p>