

Pendant Light Fittings

6050 Series (Zones 1, 21)

6450 Series (Zones 2, 21, 22)



• **Models:**

– 6050 Series

Explosion protection according
EN 50 014 / 18 for use in
categorie 2 (Zones 1 and 21) areas

– 6450 Series

Explosion protection according
EN 50 021 resp. 50 281 for use
in categorie 2 (Zone 21) and
categorie 3 (Zones 2 and 22) areas

• Housing in aluminum

Option: with lacquer coat

• Mounting with ring bolts or
adjustable mounting bracket
in stainless steel

- With connection box for easy mounting and wiring
- With or without external reflector and wire guard
- High degree of protection IP 66
- TwinArc high-pressure sodium lamps with two burners system; for long lifetime and immediate re-ignition
- Compact electrodeless high-capacity discharge lamps (induction lamp) are possible; for practically maintenance-free operation and extrem long lifetime

• **Possible lamps:**

- High-pressure sodium lamps (HSE) 110 Watts max.
- Metal halide lamps (HIE) 150 Watts max.
- Halogen lamps (QT) 250 Watts max.
- Compact lamps (TC-TSE) 23 Watts max.
- Blended lamps (LME) 160 Watts max.

To learn more about B-I-A please visit us at our
WEB site: www.BiaGmbH.com



Generalities

Suspension of light fittings

The standard light fitting has got threaded inserts M8 on the top surface where the light fitting can be fastened or/and are also suitable for screwing in of eyelets (III. 1)

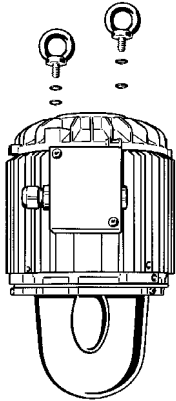

III. 1

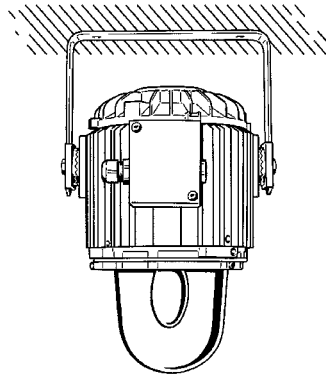

III. 2

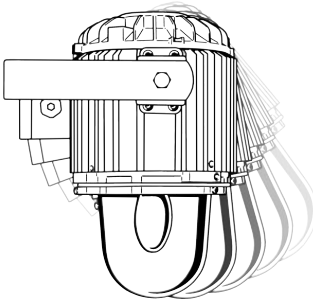

III. 3

Light fitting is adjustable by 10°

As an alternative the light fitting can also be mounted by a mounting bow on the ceiling (III. 2) or on the wall (III. 3). The light fitting can be fixed in 10° grids.

Basket protector and external reflector

The suspended light fitting can be ordered including a basket protector; but can also be installed very simply locally. Where there is a high danger the basket protector is recommendable. (III. 4)

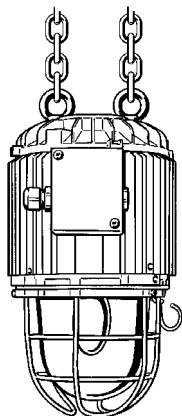

III. 4

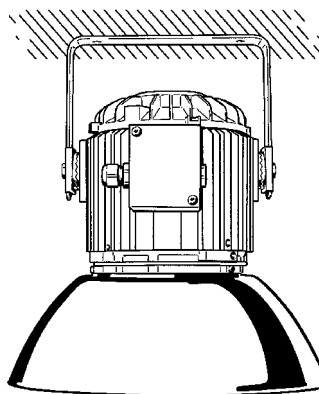

III. 5

External reflectors made of high- polished aluminium are also subsequently available. External reflectors represent a narrow angle lighting-wide spread and alternatively a narrow beam polar distribution curve.

Both additional components - basket protector and external reflector - are mountable at the light fitting.

TwinArc sodium vapour high-pressure lamps (max.70 W)

TwinArc lamps are sodium vapour high-pressure lamps which are equipped with two burners. By the extreme reduction of early failures the maintenance rates can be particularly extended. The two-burners-system of TwinArc will guarantee the immediate re-ignition after a breaking-off of circuit. So this lamp is especially suitable for difficultly accessible zones and for zones where the security is very important. The average lifetime of Twin Arc lamps is up to 55 000 hours. For the lamp capacity 50 W or 70 W the suspended light fitting 6050/6450 are deliverable.

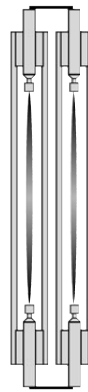

After switching-on the ignition voltage will be on both parallel burners simultaneously.



After one burner has ignited the second one - will immediately quench.



At each re-start one of both burners will be ignited. After a voltage cutoff the second burner will immediately ignite.

Induction lamp QL (max. 55 W)

The induction lamp is a compact electrodeless high-capacity discharge lamp with inductive luminosity.

Advantages of inductive illumination system QL:

- Extremely long lifetime, at ≥ 60 000 working hours and max. 10 % failure quota
- Practically maintenance-free
- Flicker-free immediate start in ≤ 0.1 sec
- Immediate re-ignition with almost full light capacity
- Constant high light current over a large supply voltage range
- Low ignition temperature and constant high luminous flux over a large temperature range - also suitable for low temperatures
- Any lighting position

By the very long lifetime of QL-system it will be used in zones with a high yearly working time or/and where a lighting system is hard accessible for maintenance purpose.

Selection table

| Version | Description | | | Temperature class | | | Ordering code | Weight kg | |
|--|-------------|--------------------------|--------------|-------------------|---------------------------|-------------------------------|--|--------------|--|
| Pendant light fitting 6050; Kat. 2; Zone 1, Zone 21 | Lamps | Version | Power | Lampholder | T _a = 40 °C | T _a = 50 °C | T _{O max.} T _a = 40 °C | | |
| | QT | max. 150 W max. 250 W | E 27 E 27 | T4 T3 | T4 - | 106 °C 142 °C | 6050/11...-12010-.0.-1 | 9,120 | |
| | LME | max. 160 W | E 27 | T4 | T3 | 123 °C | | | |
| | TC-TSE | max. 23 W | E 27 | T6 | T6 | 70 °C | | | |
| | A-L | max. 200 W | E 27 | T4 | T4 | 112 °C | | | |
| | HSE | 50 W | E 27 | T5 | T4 | 90 °C | 6050/11...-3051-.0.-1 | 10,250 | |
| | HSE | 70 W | E 27 | T5 | T4 | 90 °C | 6050/11...-3071-.0.-1 | 10,250 | |
| | HIE | 70 W | E 27 | T5 | T4 | 90 °C | 6050/11...-2071-.0.-1 | 10,250 | |
| | HIE | 100 W | E 27 | T4 | - | 125 °C | 6050/11...-2101-.0.-1 | 11,100 | |
| | HSE | 110 W | E 27 | T4 | - | 106 °C | 6050/11...-3111-.0.-1 | 11,500 | |
| | HIE | 150 W | E 27 | T4 | - | 125 °C | 6050/11...-2151-.0.-1 | 12,100 | |
| QL | 55 W | E27 | T6 | T6 | 80 °C | 6050/11...-90690-.0.-1 | 10,035 | | |

Add. to ordering code

| | | | |
|--|---------------------------|---|-------------------------------|
| Suspension | 2 x M 8 (thread in cover) | | 6050/111 |
| | with mounting clamp | | 6050/112 |
| Cable entries(in connection box) | Standard | M 25 x 1,5 1 x cable gland 1 x plug | 6050/11.1 |
| | Special | M 20 x 1,5 1 x cable gland 1 x plug | 6050/11.2 |
| | Special | 2 threaded holes NPT 3/4" | 6050/11.3 |
| | Special | 2 threaded holes NPT 1" | 6050/11.4 |
| Compensation | without compensation | | 6050/11...-...0-...- |
| | with compensation | | 6050/11...-...1-...- |
| Wire guard | without wire guard | | 6050/11...-...-0...- |
| | with wire guard | | 6050/11...-...-1...- |
| Switching off light fitting on opening | without switch | | 6050/11...-...-...0..- |
| | with switch | | 6050/11...-...-...1..- |

- Notes:
- 1) QT → Halogen-lamps
 - HIE → Metal halide lamps
 - HSE → High-pressure sodium lamps
 - QL → Induktion lamps (supplied with light fitting)
- a) The light fitting is unpainted; painting is possible (on request)
 - b) The light fittings are supplied without lamps (see accessories)
 - c) External reflector (see accessories)

Selection table

| Version | Description | | | Temperature class | | | Ordering code | Weight kg |
|---|-------------|------------|------------|---------------------------|---------------------------|---------------------------------|-------------------------------|--------------|
| Pendant light fitting 6450; Kat. 3; Zone 2, Zones 21 & 22 | Lamps | | | $T_{a \equiv 40^\circ C}$ | $T_{a \equiv 50^\circ C}$ | $T_{o \equiv 40^\circ C}^{max}$ | | |
| | Version | Power | Lampholder | | | | | |
| | QT | max. 150 W | E27 | T4 | T4 | 106 °C | 6450/11...-12010-.00-1 | 7,820 |
| | | max. 250 W | E27 | T3 | - | 142 °C | | |
| | LME | max. 160 W | E27 | T4 | T3 | 123 °C | | |
| | A-L | max. 200 W | E27 | T4 | T4 | 112 °C | | |
| | HSE | 50 W | E 27 | T5 | T4 | 90 °C | 6450/11...-3051...00-1 | 8,950 |
| | HSE | 70 W | E 27 | T5 | T4 | 90 °C | 6450/11...-3071...00-1 | 9,500 |
| | HIE | 70 W | E 27 | T5 | T4 | 90 °C | 6450/11...-2071...00-1 | 9,500 |
| | HIE | 100 W | E 27 | T4 | T4 | 100 °C | 6450/11...-2101...00-1 | 9,800 |
| | HSE | 110 W | E 27 | T4 | T4 | 106 °C | 6450/11...-3111...00-1 | 9,150 |
| | HIE | 150 W | E 27 | T4 | - | 124 °C | 6450/11...-2151...00-1 | 10,750 |
| QL | 55 W | E 27 | T6 | T6 | 80 °C | 6450/11...-90690-.00-1 | 8,735 | |

Add. to ordering code

| | | |
|----------------------------------|---|---------------------------|
| Suspension | two insert threads M 8 in the lid of the light fitting | 6450/111 |
| | with additional mounting bracket for ceiling an wall mounting | 6450/112 |
| Cable entries(in connection box) | Standard M 25 x 1,5 1 x cable gland 1 x plug | 6450/11.1 |
| | Special M 20 x 1,5 1 x cable gland 1 x plug | 6450/11.2 |
| | Special 2 threaded holes NPT 3/4" | 6450/11.3 |
| | Special 2 threaded holes NPT 1" | 6450/11.4 |
| Compensation | without compensation | 6450/11.....0..... |
| | with compensation | 6450/11.....1..... |
| Wire guard | without wire guard | 6450/11.....0.... |
| | with wire guard | 6450/11.....1.... |

- Notes:
- 1) QT → Halogen-lamps
 - HIE → Metal halide lamps
 - HSE → High-pressure sodium lamps
 - QL → Induktion lamps (supplied with light fitting)
- a) The light fitting is unpainted; painting is possible (on request)
 - b) The light fittings are supplied without lamps (see accessories)
 - c) External reflector (see accessories)

Technical Data

| | | |
|-----------------------------------|--|--|
| Version | 6050 (Zone 1, Zone 21) | 6450 (Zone 2, Zones 21 & 22) |
| Explosion protection | | |
| Gas explosion protection | ⊕ II 2 G EEx de IIC T. ¹⁾ | ⊕ II 3 G EEx n R II T. ¹⁾ (Zone 2) |
| Dust explosion protection | ⊕ II 2 D IP 66 T _{O max.} ¹⁾ | ⊕ II 2 D IP 66 T _{O max.} ¹⁾ (Zone 21) ⊕ II 3 D IP 66 T _{O max.} ¹⁾ (Zone 22) |
| | ¹⁾ see selection table | ¹⁾ see selection table |
| Certificates | | |
| Gas explosion protection | PTB 03 ATEX 1096 | Zone 2: PTB 03 ATEX 1096 |
| Dust explosion protection | PTB 03 ATEX 1096 | Zone 21: PTB 04 ATEX 2084 Zone 22: PTB 04 ATEX 2085 |
| Marking | CE 0102 | |
| Rated voltage | 220 V / 230 V / 240 V, AC ± 6 %, 50 Hz, others on request | |
| Rated current | Size 1 6050 / 6450; lampholder E 27 | |
| | Lamps | Power I _N |
| | Halogen-lamps | QT 150 W 0,65 A 250 W 1,1 A |
| | Metal halide lamps | HIE 70 W 0,95 A 100 W 1,1 A 150 W 1,8 A |
| | High-pressure sodium lamps | HSE 50 W 0,76 A 70 W 0,98 A 110 W 1,22 A |
| | Blended lamps | LME 100 W 0,46 A 160 W 0,73 A |
| | Compact lamps | TC-TSE 23 W 0,1 A |
| | Incandescent lamps | A-L 150 W 0,65 A 200 W 0,87 A |
| | Induktion lamps | QL 55 W 0,26 A |
| Power factor | High-pressure lamps compensated cos φ > 0,9 | |
| Protection class | I (internal + external PE / PA-connection) | |
| Connection | L1 + N + PE für 2,5 mm ² solid / flexible | |
| Material | | |
| Housing material | Light metal | |
| Glass cover | Pressed glass cover resistant to temperature changes | |
| Gasket | NBR-gasket | |
| Internal reflector | Aluminium, high polished | |
| External reflector | Aluminium | |
| Wire guard | Steel wire (stainless steel) | |
| Housing lock | M 4, Torx-screw head | |
| Installation orientation | ceiling mounting respectively ± 40 ° slewing angle | |
| Mounting | via 2 x M 8 insert threads in the lid of the light fitting alternative: via additional mounting bracket (stainless steel), adjustable in 10 ° steps | |
| Degree of protection | IP 66 acc. to EN 60529 | |
| Ambient temperature | - 20 °C ... + 40 °C / + 50 °C | |
| Version | 6050 (Zone 1, Zone 21) | 6450 (Zone 2, Zones 21 & 22) |
| Switch-off | 2 pole; when opening glass cover (Option) | no switching off when opening glass cover |
| Wire guard and external reflector | can be fitted later; simple to mount | |

Technical Data

Cable glands

| | | |
|----------|---------------------------------|--|
| Standard | 2 x M 25 x 1,5 | 1 x cable gland, cable dia range: 7 mm ... 17 mm 1 x plug |
| Special | a) 2 x M 20 x 1,5 | 1 x cable gland, cable dia range: 6 mm ... 13 mm 1 x plug |
| | b) 2 x threaded holes NPT 3/4 " | |
| | c) 2 x threaded holes NPT 1 " | |

Dimension drawings (all dimensions in mm) - subject to alterations

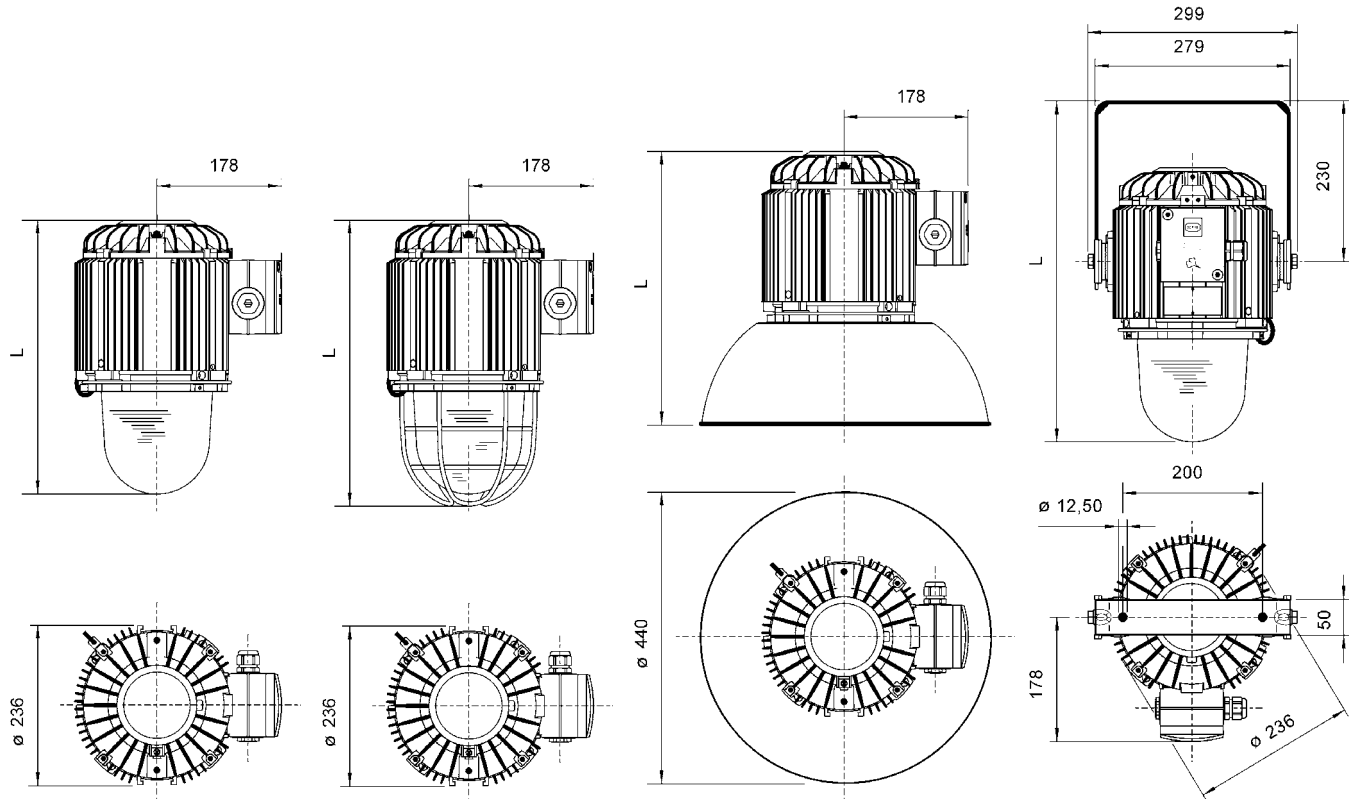

without wire guard

with wire guard

with external reflector









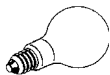

with mounting bracket

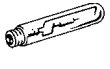
Pendant light fitting 6050 and 6450

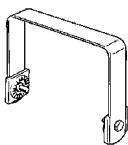

Dimension L

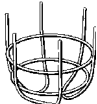
| | Series 6050, Zone 1, Zone 21 | Series 6450, Zone 2; Zones 21 & 22 |
|----------------------------------|------------------------------|------------------------------------|
| without wire guard | 392 | 381 |
| with wire guard | 409 | 398 |
| with external reflector | 392 | 381 |
| with adjustable mounting bracket | 525 | 514 |

Accessories and spare parts

| Designation | Illustration | Description | Ordering code | Weight kg |
|-----------------------------------|---|---|-------------------|--------------|
| Incandescent lamps | | Lampholder Lighting current Power | | |
| |  | E 27 3 100 lm 200 W | 5126250 | 0,034 |
| Compact lamps TC-TSE |  | E 27 1 500 lm 23 W | 4646090 | 0,030 |
| Blended lamps LME |  | E 27 3 150 lm 160 W | 4616660 | 0,082 |
| Halogen lamps QT |  | E 27 2 500 lm 150 W | 4646120 | 0,040 |
| | | E 27 4 200 lm 250 W | 4616400 | 0,060 |
| Metal halide lamps HIE |  | E 27 6 500 lm 70 W | 4637750 | 0,080 |
| | | E 27 8 000 lm 100 W | 4637760 | 0,160 |
| | | E 27 14 000 lm 150 W | 4637770 | 0,170 |
| High-pressure sodium lamps HSE |  | E 27 6000 lm 70 W | 4618880 | 0,074 |
| | | E 27 8000 lm 110 W | 4646080 | 0,150 |
| | | * to operate without starter | | |
| Twin-Arc-lamps HSE (SHP-S) |  | E 27 3 600 lm 50 W | 4619040 | 0,066 |
| | | E 27 6 000 lm 70 W | 4619050 | 0,080 |
| Ring bolts |  | M 8, to mount directly into inserts, 1 pair | 6000803900 | 0,100 |
| Mounting bracket |  | complete; in stainless steel (for additional mounting) | 6050801550 | 2,100 |
| External reflector |  | complete with mounting parts Material: Aluminium high polished | | |
| | | broad bowl | 6050801580 | 0,216 |
| | | spot | 6050802580 | 0,150 |
| Wire guard |  | complete with mounting parts Material: Steel wire, stainless steel | 6050801140 | 0,560 |
| Replacement glass for 6050 |  | Protective glass with fixing-ring | 6050001580 | 2,760 |
| Replacement glass for 6450 |  | Protective glass with fixing-ring | 6450001580 | 2,400 |

Accessories and spare parts

| Designation | Illustration | Description | | Ordering code | Weight kg |
|--------------|---|--------------------|------------|-------------------|--------------|
| Cable glands |  | in moulded plastic | | | |
| | | 8161/5-M 20-13 | 1 piece | 8161077010 | 0,011 |
| | | 8161/5-M 20-13 | 50 pieces | 8161025030 | 0,600 |
| | | 8161/5-M 25-17 | 1 piece | 8161078010 | 0,016 |
| Plug |  | 8161/5-M 25-17 | 50 pieces | 8161026030 | 0,850 |
| | | in moulded plastic | | | |
| | | 8290/3-M 20 x 1,5 | 1 piece | 8290008590 | 0,004 |
| | | 8290/3-M 20 x 1,5 | 100 pieces | 8290045590 | 0,600 |
| | | 8290/3-M 25 x 1,5 | 1 piece | 8290009590 | 0,006 |
| | | 8290/3-M 25 x 1,5 | 100 pieces | 8290046590 | 0,800 |

We reserve the right to make alterations to the technical data, weights, dimensions, designs and products available without notice. The illustrations cannot be considered binding.

To learn more about B-I-A please visit us at our
WEB site: www.BiaGmbH.com

